

Nicolazzi

28010 ALZO (NO) via P.Durio 119 Tel. 0322-969672 Fax 0322-969532 www.nicolazzi.it info@nicolazzi.it

INSTALLATION AND CARE & MAINTENANCE GUIDE

Installation guide

Basin pillar tap

Art. Z2617

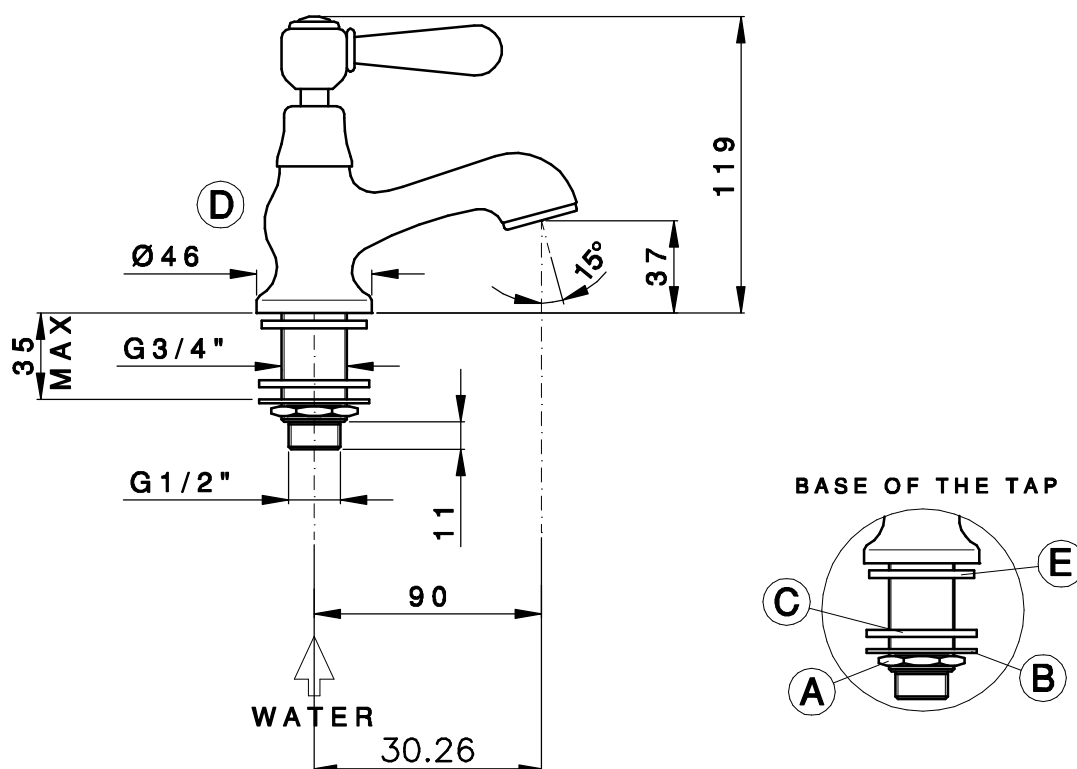

a - Preparation

Flush out the pipework to remove any foreign matter.

The hot supply should be on the left when viewed from the front of the fitting.

b - Assembly

- Unscrew the nut (A). Disassemble the metal disk (B) and the rubber washer (C).
- Introduce the faucet (D) in the hole of the wash basin, placing the washer (E) between the base of the faucet and the wash basin,
- Fix the faucet (D) placing, before the rubber washer (C) and then the metal disk (B) and the nut (A).
- Connect water.

c - Before use

Turn on the Hot and Cold supplies to the faucet.

Minimum temperature for Cold water supply to the faucet is 10° C.

Maximum temperature for Hot water supply to the faucet is 65° C.

Minimum recommended pressure is 1 bar - Maximum recommended pressure is 5 bar.

Check the installation carefully for leaks.

If further building work is to be carried out in the vici of the faucet, it should be covered to prevent paint, adhesive, etc. from damaging the surface.