



OFFICINA  
**NICOLAZZI**  
DAL 1960



**3 Hole Bridge sink mixer with side spray**  
**Art: Z1460WS**

## Specifications

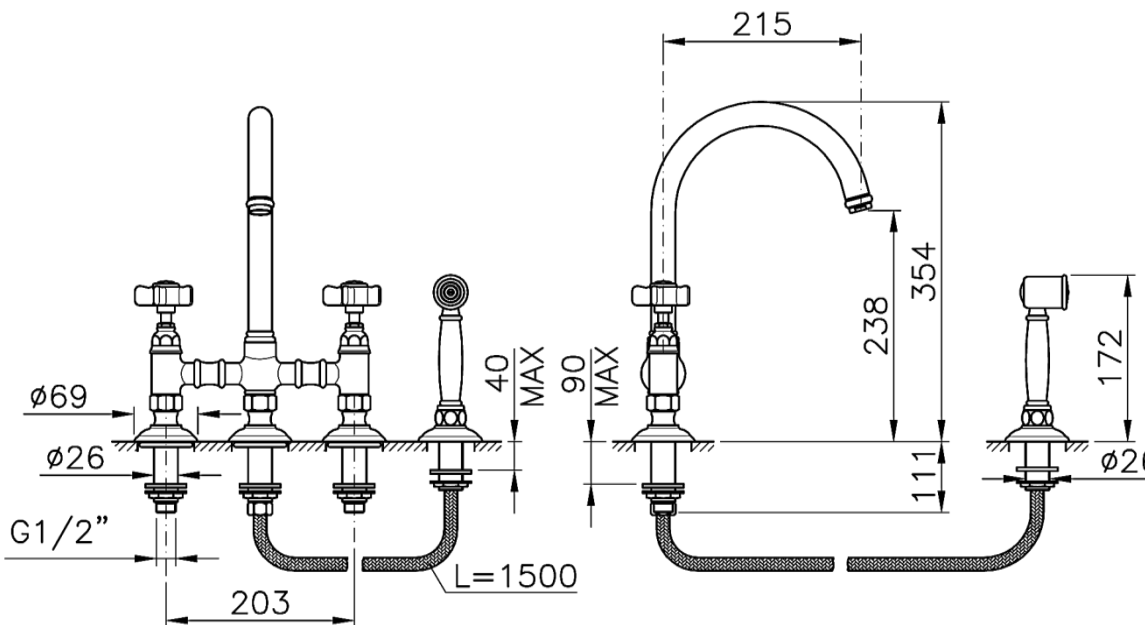

### Available replacement handles:



- El Capitan Handle



- 78 Mont Blanc Handle



- 18 Dame Anglaise



- 70 Half Dome

- Handmade in Italy since 1960
- 1/4 Turn valves handmade at Nicolazzi Factory
- Lead Free Brass Compliant to AZ/NZS 3718
- Suitable even and uneven pressure
- Handles are interchangeable



WM22315  
AS/NZS3662

Canterbury Sink & Tap Co.

Max/Min Operating  
Pressure: 100/500kPa

OFFICINA  
**NICOLAZZI**  
DAL 1960

## Important Notice    Model : Z1460WS

---

**CAREFULLY READ THROUGH THESE INSTRUCTIONS BEFORE INSTALLATION AND USE OF ALL TAP WARE AND WALL VALVES**

### **INSTALLATION and WARRANTY INSTRUCTIONS**

#### **TECHNICAL INFORMATION**

All flexible hoses are designed and manufactured for use with water in exposed locations only. Do not expose to household cleaners, chlorine, chloride, hydrochloric acid or other corrosive chemicals.

All connections with threads M10x1 male must be hand tighten. Do not over tighten. Over tightening may cause damage to the hose.

All tap ware washers and o-rings are designed and manufactured for use with water. Do not expose to household cleaners, chlorine, chloride, hydrochloric acid or other corrosive chemicals.

Our tap ware is designed for use with the temperatures and pressures listed below:

- minimum cold water supply 10 °C
- maximum hot water supply 62 °C
- minimum pressure 100 kPa
- maximum pressure 500 kPa
- maximum fixing torque value = 13.6 Nm

Please note: The recommended pressure for best performance is between 270 kPa and 420 kPa. More pressure than 420 kPa or less pressure than 270 kPa may affect the diverting action in side spray tap ware.

Do not use any Nicolazzi tap ware with sulphurous water.

The minimum temperature for all tap ware is 10 degrees Celsius . Below 10 degrees Celsius will void the warranty.

When available, filter systems must be placed between hot and cold supply lines and the tap ware. Improper use or non-use of filters may make diverting tap ware with hand sprays perform poorly.

Don't modify the tap ware and their components

Use only original spare parts if there are replacements to be ordered. Installation must be made by authorized plumbers or installers. Improper installation or diagnosis of problems is not covered by the warranty. Yearly maintenance of cleaning and flushing is recommended.

Operation and use of any tap ware or wall valve that do not conform to these technical instructions will void the warranty.

# Installation Instructions    Model : Z1460WS

## 1 Preparation

- Flush out the pipework to remove any foreign matter.
- The hot supply should be on the left when viewed from the front of the fitting.
- Measure and cut tap hole spacing of **101 mm**, centre to centre on the wash basin. Three holes are required for the tap set.

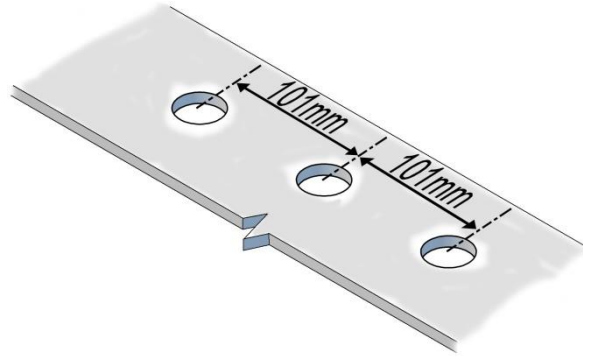

- ## 2
- Tap cut out hole sizes : Maximum **32mm** diameter.
  - Under side clearance : Maximum **90mm**

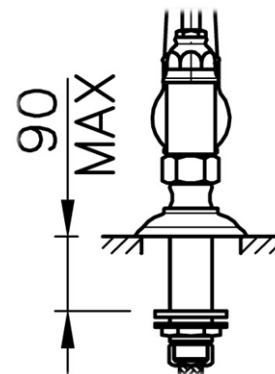
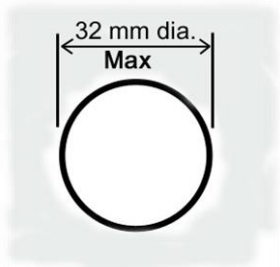

- ## 3
- Insert the tap **B**, into work top mounting holes.
  - Insure o-ring **A**, is located between tap base and worktop surface.

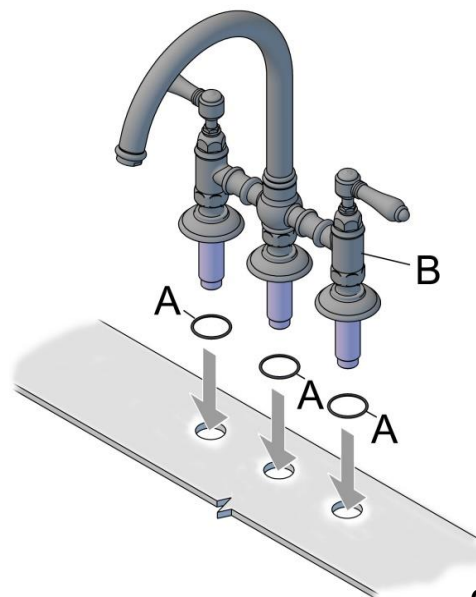

Continue.....

## Installation Instructions Model : Z1460WS

- 4
- Under the sink, place the supplied rubber gaskets **C**, onto the tap thread extensions. Then screw the mounting nuts **D**, onto the thread extensions. Screw the mounting nuts until the rubber gaskets mate up with the underside of the sink.

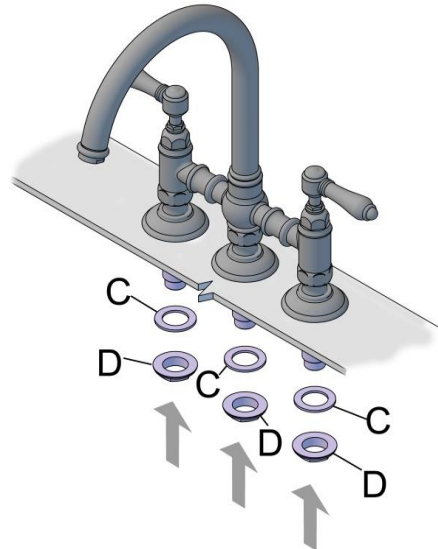

- 5
- Tighten each nut using a suitable size spanner or smooth jaw shifter.

Note: The under deck mounting surface must be flat. If the mounting surface is irregular, the nut may not be secured, and the tap will be loose on the sink.

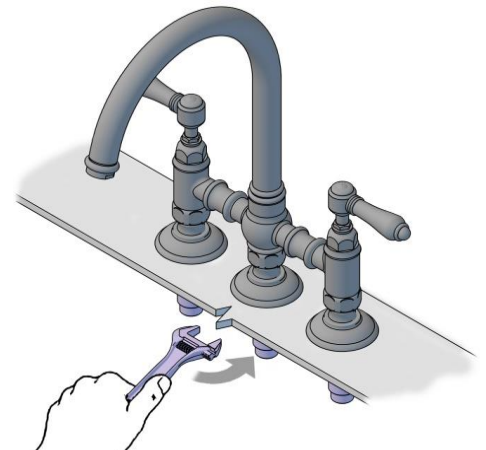

6 **Hand Spray Preparation**

- Measure and cut Hand sprayer hole, with a **minimum hole spacing of 120mm** from tap body centre line to Hand sprayer centre line. Hand spray **maximum** distance should be **250mm** from the tap body centre line to centre line of the Hand spray.

Note: make sure the hand spray hole is positioned a **minimum** of **120mm** away from the main body of the tap. ( **Min.** Centre to Centre hole distance of 120mm)

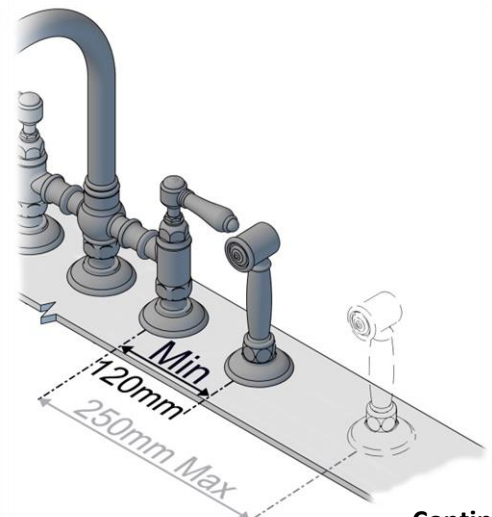

See our video : <https://youtu.be/00TOv-nmFzY>

Continue.....

## Installation Instructions    Model : Z1460WS

- 7**
- Hand Spray cut out hole sizes : Maximum **32mm** diameter.
  - Under side clearance : Maximum **40mm**

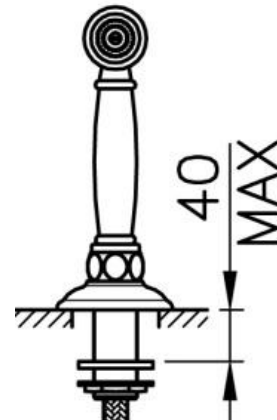
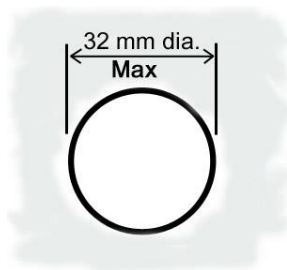

- 8**
- Insert the hand spray escutcheon into the cut out hole.
  - Ensure the o-ring is fitted between the escutcheon base and worktop surface.
  - Install the rubber gasket onto the escutcheon thread extension, followed by the nut **D**. Secure on to the worktop underside, but do not over tighten.

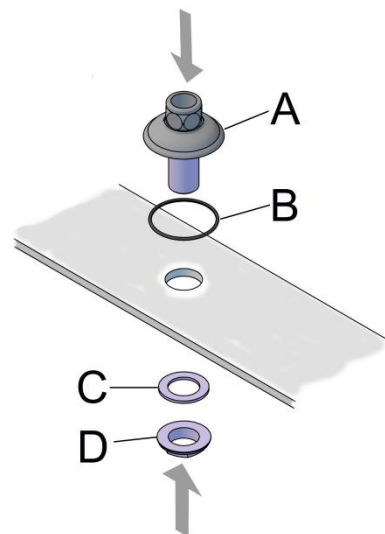

- 9**
- Install the black hand spray hose to the supply from the tap under the sink.
  - Guide the 9mm male end up through the escutcheon.
  - Install the hand spray with the required flat washer with screen on top of the sink.

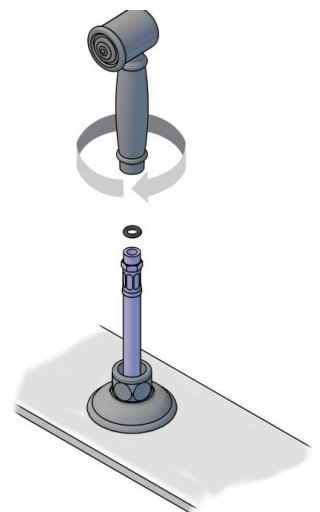

Continue.....

## Installation Instructions    Model : Z1460WS

- 10
- Connect the supply lines to the hot and cold supplies securely.

Please note: make sure the rubber washers with the screens are used. These screens will prevent debris from entering the diverter.

- Turn on the water for the hot and cold.
- Check the diverting action by operating the hand shower.

***How to use the Hand Spray for the first time.***

**IMPORTANT**

- Turn the tap on and run the water at half strength.
- Press the hand spray SLOWLY to engage the hand spray.

This will engage the diverter of hand spray for the first time for smooth operation.

Please note: If there is a 99% divert or small trickle of water out the spout when using the hand spray that is acceptable. Due to water conditions, a 100% diverting action is not always possible.

- Check for leaks.

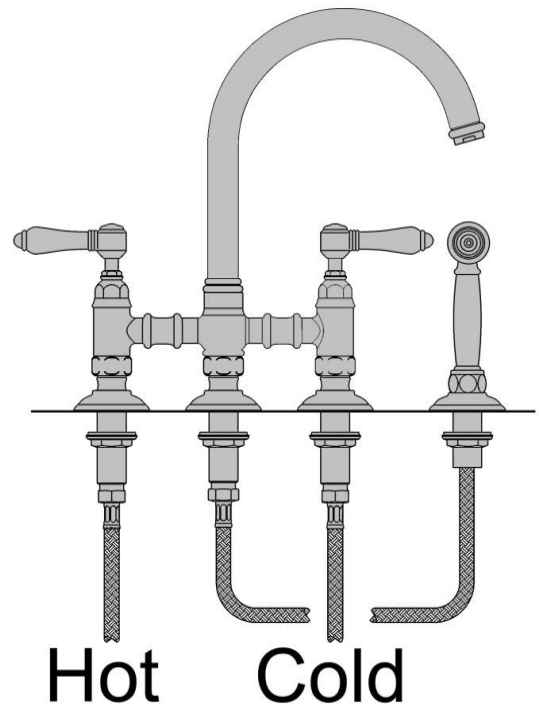

# Spare Parts list Model : Z1460WS

(\* ) NOT AVAILABLE AS SPARE PART

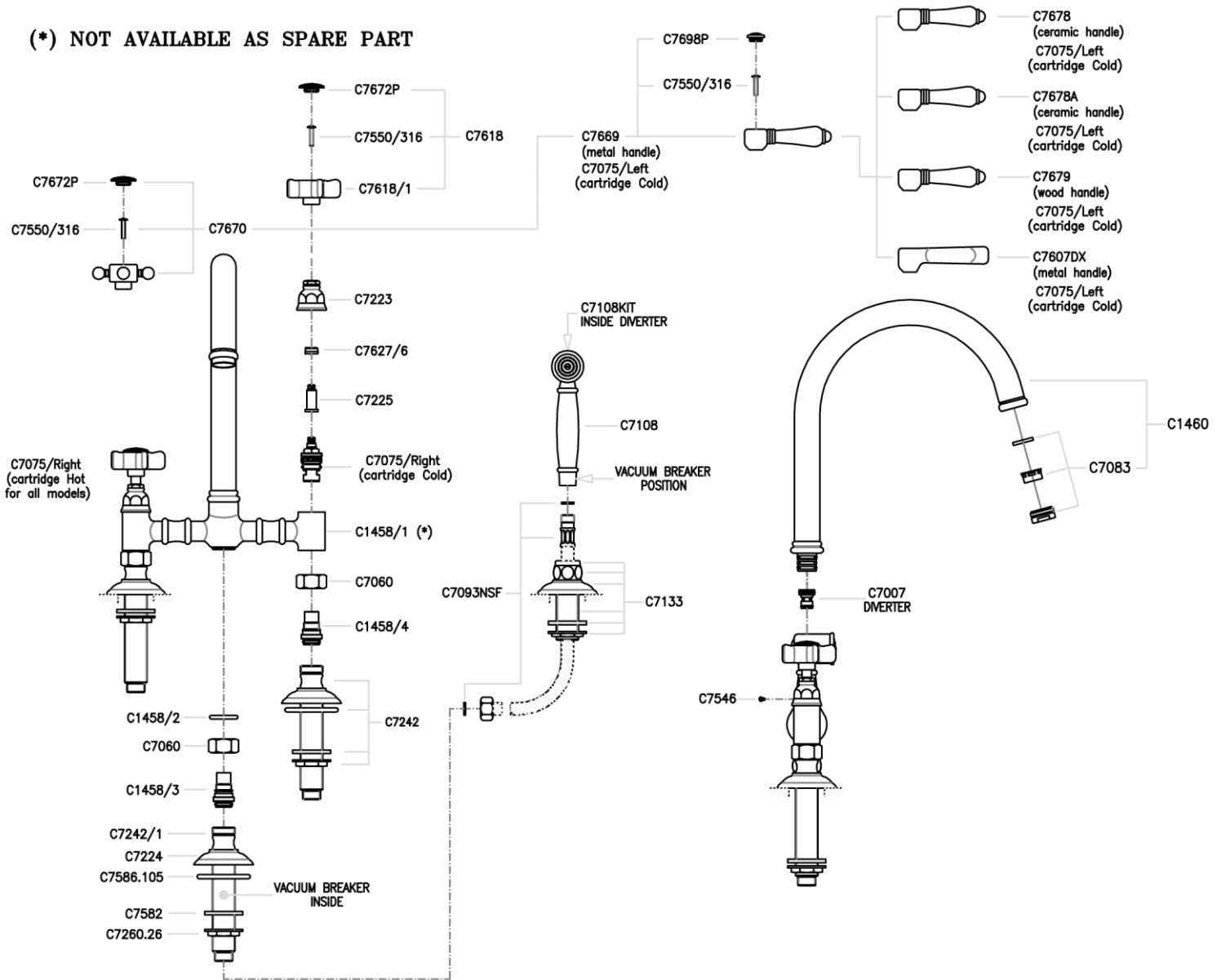

## Care and Maintenance Instructions Model : Z1460WS

### MAINTENANCE FOR THREE HOLE/TWO LEVER TAP WARE WITH TWO LEVER DESIGN

#### INSTRUCTIONS FOR REPLACEMENT OF THE HOT OR COLD CARTRIDGE

Do not replace the cartridge if there is low flow or no flow. Low flow or no flow is caused by obstruction or kinking of supply hoses.

1

- Turn off the hot and cold supply lines to the tap set. (Not shown).
- Remove the handle and retaining flange. See "Removing and Replacing handle" section, Pg 9.

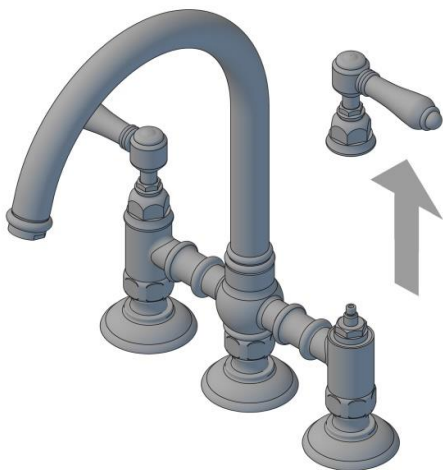

2

- Remove the cartridge with a smooth jawed 17mm shifter.

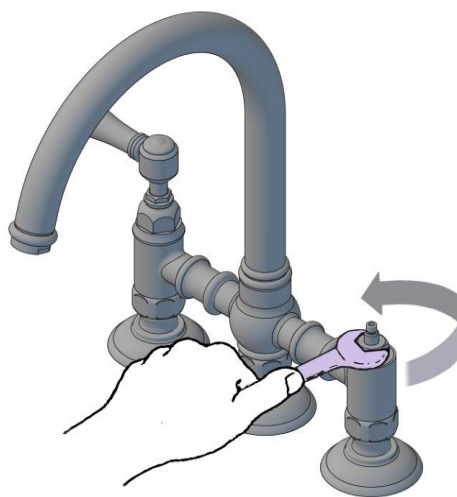

3

- Install new cartridge.
- Secure the cartridge with a smooth jawed shifter.

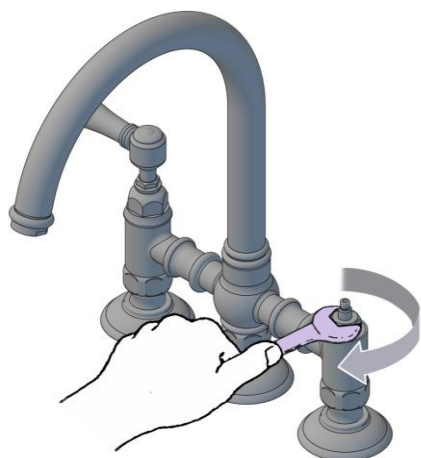

4

- Install lever and retaining flange. **DO NOT USE A SHIFTER TIGHTEN BY HAND ONLY!**
- Turn on supply line and test for leaks. (Not shown).

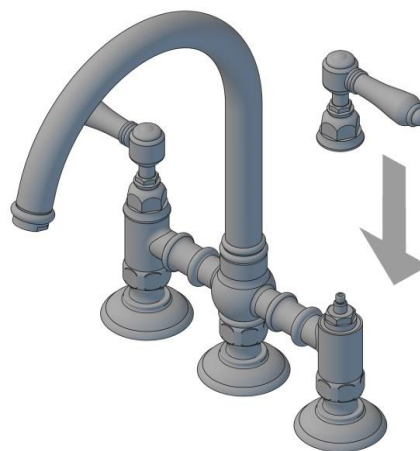

**Note:** Do not over tighten as this could damage the ceramic cartridge!

Continue.....



## Care and Maintenance Instructions Model : Z1460WS

### Removing and replacing a handle

MODEL SHOWN : Z1460

- 1 ▪ Loosen and unscrew the retaining flange **A**, from the tap body



- 2 ▪ Once totally loose, simply remove the handle from cartridge spline.



- 3 ▪ To reassemble, reverse the disassembly procedure, given above.  
 ▪ The retaining flange only needs to be hand tight.

**NOTE: DO NOT USE A SHIFTER TIGHTEN BY HAND ONLY !**

Do not over tighten as this could damage the ceramic cartridge!

**NOTE:** At any time, should the handle feel loose, retighten the retaining flange.

See our video: <https://youtu.be/PUbD3GHgg58>

#### Available replacement handles:

- El Capitan Handle
- 78 Mont Blanc Handle
- 78A Mont Blanc Antique Crackle
- 78B Mont Blanc Black

## Care and Maintenance Instructions Model : Z1460WS

### INSTRUCTIONS FOR SERVICING THE HAND SPRAY

Please note: If the hand spray is dripping constantly when using the tap, the hand spray can be serviced by either stretching the spring or replacing the cartridge. A small drip after use that stops is sometimes normal, as there is a small space between the black aerator and the stop mechanism that holds 36 teaspoons of water. A drip or two after use is normal.

#### [A] How to stretch internal the Hand spray head spring

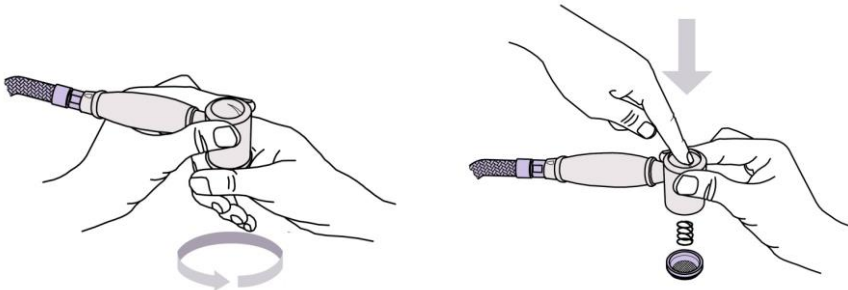

- ① Unscrew ring the face ring
- ② Remove black faceplate
- ③ Push the button or remove with tool.
- ④ Stretch the spring slightly
- ⑤ Reassemble and test.

#### [B] Changing the cartridge in the hand spray

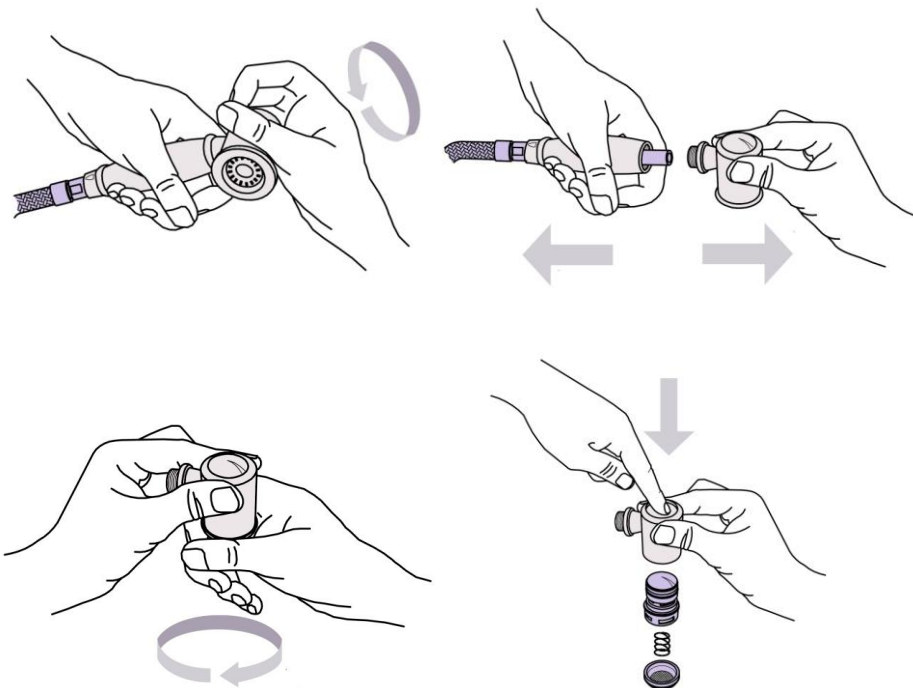

- ① Unscrew the spray head.
- ② Unscrew the faceplate ring.
- ③ Push the button in to eject the cartridge from the head.
- ④ Remove the decorative button from the old assembly.
- ⑤ Put on the new assembly.
- ⑥ Insert in the metal head.
- ⑦ Install the spring, aerator and ring.
- ⑧ Install back on the handle.
- ⑨ Test the unit for leaks.

Continue.....

## Care and Maintenance Instructions Model : Z1460WS

### [C] Cleaning or replacing the backflow preventer c7076

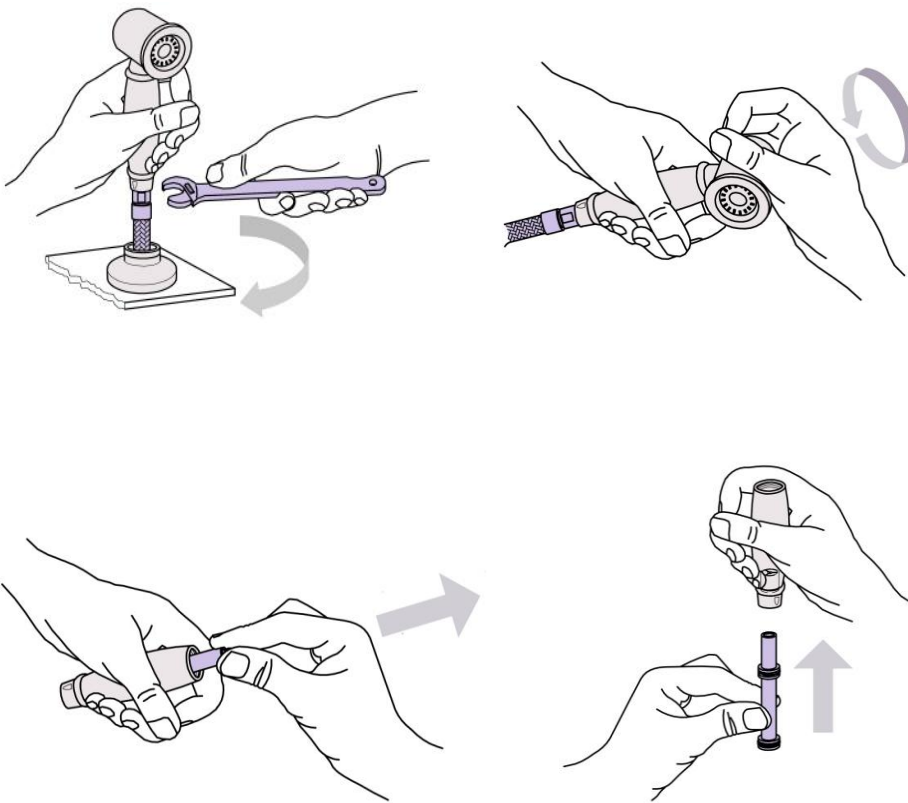

- 1 Disconnect the flexible hose from the spray head
  - 2 Remove the spray head from the handle
  - 3 Remove the nylon insert
  - 4 Remove the back flow preventer- not show
  - 6 Replace or clean the check valve
  - 7 Insert new or serviced check valve back into the handle
- Note:** make sure the flow restrictor is not backwards
- 8 Reverse steps and test.

# Care and Maintenance Instructions Model : Z1460WS

## Spare Parts List C7108 Hand spray kit

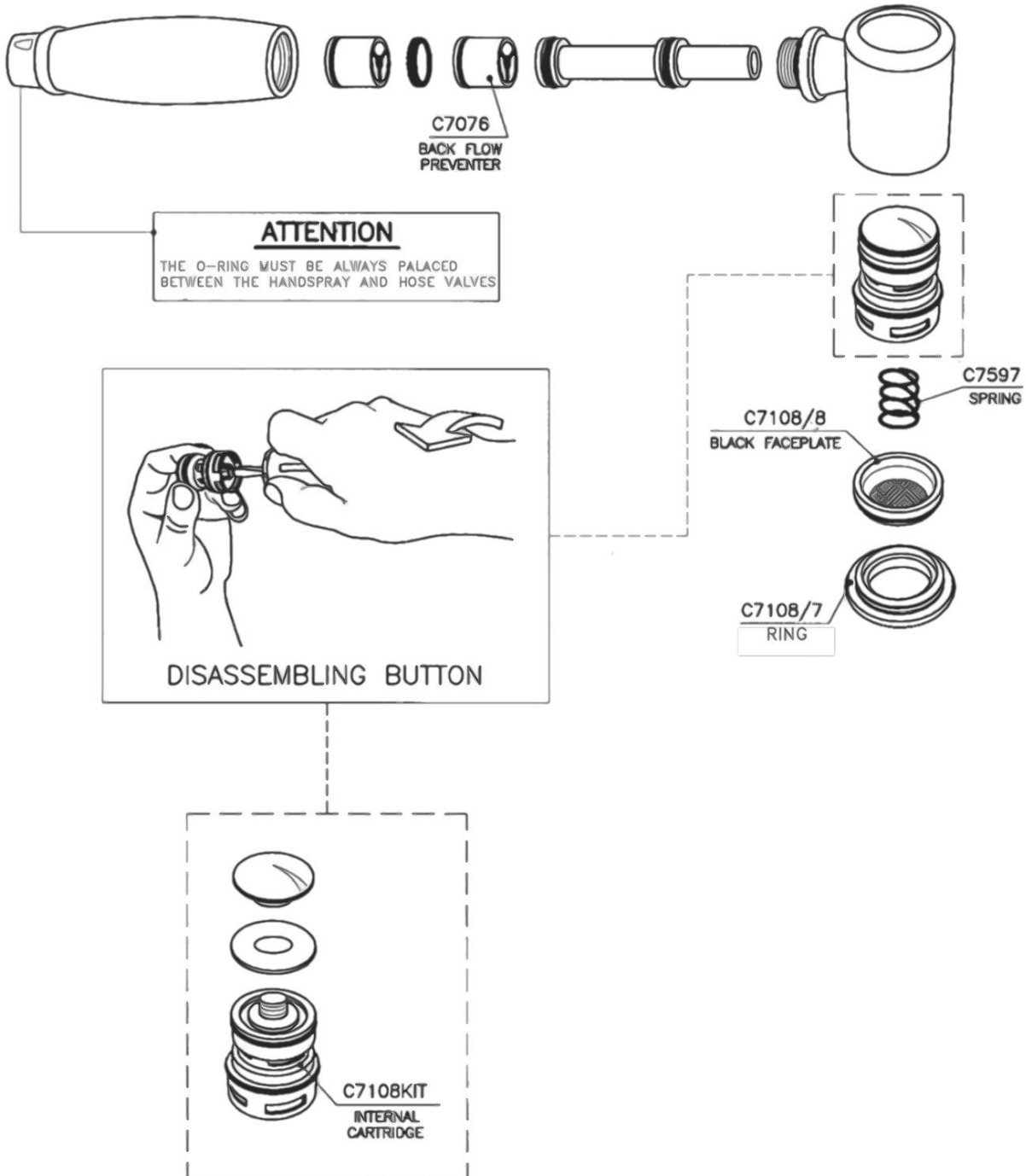

## Care and Maintenance Instructions Model : Z1460WS

### LOW FLOW OR NO FLOW TROUBLESHOOTING INSTRUCTIONS

Current kitchen taps have a max flow rate of 7 Litres per minute from the aerator and the hand spray.

If you are experiencing low flow from the spout: **Do not change the cartridge**

- Unscrew and clean the aerator -1
- Unscrew and clean the filters inside the supply connections- 3
- Check the supply lines for kinks or obstructions-3
- Make sure the supply line stops are fully on. Not shown

If your tap has a hand spray, and your hand spray has obstructed flow or no flow:

- Check the hand spray hose for kinks-5
- Unscrew and clean the hand spray filter-4
- Clean the aerator in the hand spray-2

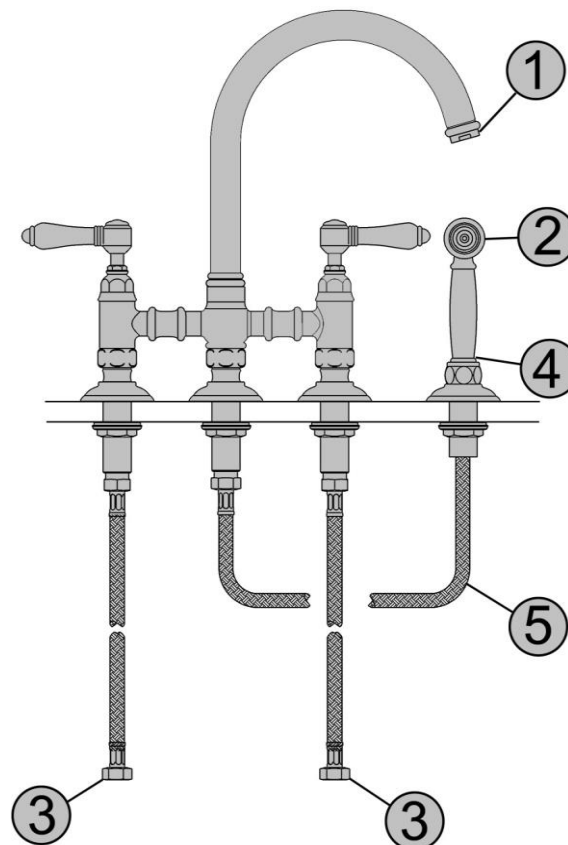

## Care and Maintenance Instructions Model : Z1460WS

### Care of external finishes

Nicolazzi products are all authentic finishes that have not been coated with any product. After each use, pat the fixture down to remove any excess water. This will prevent any water spotting or mineral build-up. Use only soft liquid soap and water to clean the surface. Use a soft brush to clean any gaps. Avoid any products that have ammonia or alcohol like Windex, Jif or Ajax. These products can damage the finish leaving black or white spots. Never use on abrasive products on tap ware or this will void the warranty.

Live Finishes DO NOT carry a warranty as they are living finishes and will change over time.

Raw Brass, Brush Brass ( To make the brass lighter again rub the brass tap with lemon juice, this will lighten the dark colouring).

Shiny Brass, Polished Nickel has an ageing process and will tarnish over time.

Tuscan Brass is a living finish and also carries NO warranty. It will lighten with use. To extend the life of the finish, apply Bruno's Wax by patting it on, letting it dry and patting it off. Never rub or buff this finish.

**WARNING:** The use of cleaning products not recommended might irreparably harm the surfaces of the tap, which in such cases are not covered by our warranty.

### Lime scale build up

The tap is fitted with an aeration device in the Hot/Cold water outlet.

This may need occasional cleaning especially in hard water areas.

This is accomplished by unscrewing the outlet in a counter clockwise direction, dismantling and leaving the inner screen mesh immersed over night in vinegar